

FERRARI TRIBUTE 1000 MIGLIA 2022

Brescia, from 13th to 18th June 2022

SPECIAL RACE REGULATIONS

This draft of the Special Race Regulations together with its attached: Times and Distances Table – Route maps – Signage of controls - Table of coefficients – Table of scores for Time Trials - Table of scores for Average Trials, was sent to ACI SPORT for approval the 25th February 2022 and published on the organizer website on the 28th February 2022.

ORGANISATION: 1000 Miglia Srl

PREVIOUS FERRARI TRIBUTE 1000 MIGLIA WINNERS

Year	Drivers	Car	Cyl.	Cm³	CV	Brescia-Rome	Total penalty	Avg.
2010	Giardina - Di Serio	Ferrari Modena F1	8	3.586	400	2000	516	-
2011	Verghini - Fuso	Ferrari 512 TR	12	4.942	428	1992	490	-
2012	Verghini - Fuso	Ferrari 512 TR	12	4.942	428	1992	698	-
2013	Mingotti - Mingotti	Ferrari 458 Italia	8	4.499	570	2011	707	-
2014	Garelli - Garelli	Ferrari 458 Speciale	8	4.499	605	2014	1772	14666
2015	Garelli - Garelli	Ferrari 458 Speciale	8	4.499	605	2014	1234	18682
2016	Garelli - Garelli	Ferrari F12 TDF	12	6.262	570	2016	1061	19128
2017	Garelli - Garelli	Ferrari F12 TDF	12	6.262	570	2016	1165	24315
2018	Bianchi - Mozzi	Ferrari California	8	4.296	460	2010	605	33164
2019	Mozzi – Biacca	Ferrari 458 Spider	8	4.499	605	2012	868	34106
2020	Al Rifai – Mozzi	Ferrari 488 Pista	8	3.902	720	2018	589	35714
2021	Mozzi – Biacca	Ferrari 458 Spider	8	4.499	605	2012	868	34106

INDEX

Articles:

1.	DEFINITIONS.....	4
2.	ORGANISATION	6
3.	PROGRAMME	7
4.	RACE.....	9
5.	ROUTE	9
6.	COMPETITORS, DRIVERS AND CARS ALLOWED	9
7.	COMPETITION NUMBER AND STARTING ORDER.....	12
8.	ENTRIES.....	12
9.	GENERAL OBLIGATIONS.....	17
10.	RUNNING OF THE COMPETITION.....	20
11.	MAXIMUM LATENESS	22
12.	PENALTIES AND DISCIPLINARY MEASURES.....	22
13.	CLASSIFICATION-PROTESTS AND APPEALS.....	23
14.	PRIZES	23
15.	GENERAL RULES	24
16.	INSURANCE	25
17.	APPENDIXES	25
	Facsimile of the Medical Certificate for non-competitive sports activity	27
	Facsimile of the Medical Certificate for competitive sports activity	28
	Positioning of the Competition numbers on the cars	29
	Itinerary, Times and Distance Table	29
	(the TDT will be distributed together with the Road book)	
	Maps.....	30
	(The maps may be subject to modification and will be distributed together with the Road book)	
	Signage of Controls.....	31
	Table of scores for Time Trials (PC/TT)	33
	Table of scores for Average Trials (PM/AT)	35

Article 1 - DEFINITIONS

Unless otherwise defined in the body of these SRR or in the General Terms and Conditions, the following terms shall have the following meanings.

- 1.1 **ASN:** means the National Sporting Association/Federation recognised by the International Automobile Federation in each country as the only sporting power qualified to apply the code of ethics adopted by the same and to regulate motor sports in all the territories under its jurisdiction.
- 1.2 **Admitted Drivers:** means the Crew members admitted and verified to drive the car entered by the Competitor.
- 1.3 **Chairman of the Stewards:** these are the officials indicated in Art. 2.4 of these SRR.
- 1.4 **Clerk of the Course:** means the official as per art. 2.4 of these SRR.
- 1.5 **Co-Driver:** means the Crew member assisting the driver.
- 1.6 **Competitor(s):** means the natural or legal person holding a Sports Licence suitable to enter a car and its drivers for the Event.
- 1.7 **CO/TC:** means the time control(s) that regulates/regulate the timing of the race.
- 1.8 **CPI:** means the personal identification mark suitable to uniquely and incontrovertibly identify a Driver.
- 1.9 **Crew:** means the crew appointed by the Competitor for each entered and/or admitted car composed of a maximum of 2 (two) Drivers.
- 1.10 **CSN:** means the national sports code adopted by ACI Sport.
- 1.11 **CT/PC:** means the passage controls.
- 1.12 **Driver:** means the natural person who takes part in the race with the role of driver and/or co-driver of an entered car. The driver(s) is/are indicated by the Competitor and must be in possession of the requirements of art. 6 of these SRR.
- 1.13 **Driver:** means the Crew member driving the car.
- 1.14 **FIA HERITAGE CERTIFICATE:** means the certificate issued by the Federation Internationale de l'Automobile.
- 1.15 **FICHE ACI SPORT:** means the national technical document issued by Automobile Club Italia.
- 1.16 **FIVA INTERNATIONAL IDENTITY CARD:** means the international document issued by the Fédération Internationale des Véhicules Anciens.
- 1.17 **General Terms and Conditions:** these are the general terms and conditions containing the terms and conditions of entry of competitors and forming an integral part of these SRR for anything not expressly derogated from or supplemented by the same.
- 1.18 **GPS TRACKER:** means the electronic equipment made available by the Organiser and installed on the vehicle.
- 1.19 **Guest Car:** means a car entered with a specific application for entry and admitted to a special classification.
- 1.20 **HTP/FIA:** means the *Historical Technical Passport* of the car issued by the *Federation Internationale de l'Automobile*.
- 1.21 **Leg:** means the leg of the race scheduled in the Programme.
- 1.22 **Operating and Selection Committee:** means the committee composed of the members referred to in art. 2.3 of these SRR, appointed by the Organiser, with the task of proposing the admission to and/or exclusion of the cars from the Event.

- 1.23 Organiser:** means 1000 Miglia S.r.l. with registered office in Brescia, Via Enzo Ferrari 4/6, holder of ACI Sport licence no. 356540, Tax Code and VAT no. 03440020984, registered with the Brescia Companies' Register under no. 534270.
- 1.24 Paddock:** means the area set up by the Organiser to carry out the administrative checks and scrutineering for the race.
- 1.25 PC/TT:** means the time trials.
- 1.26 PM/AT:** means the average trials.
- 1.27 Programme:** means the Race programme referred to in art. 3 of these SRR.
- 1.28 Race:** means the car race called "FERRARI TRIBUTE 1000 MIGLIA 2022"
- 1.29 Race Officials:** means the race officials referred to in Article 2.4 of these SRR
- 1.30 Registered Trademarks:** means the following trademarks: "FERRARI TRIBUTE 10000 MIGLIA", "MILLE MIGLIA", "1000 Miglia" both verbal and figurative.
- 1.31 RNS:** means the National Sporting Regulations adopted by ACI Sport and its sector regulations, as applicable.
- 1.32 Road Book:** means the document prepared by the Organiser indicating the route of the Race.
- 1.33 SRR:** means these Special Race Regulations.
- 1.34 TDT:** means the itinerary, times and distance table attached to the SRR, the final version of which is included in the Road Book or in the Information Bulletins.
- 1.35 Technical Support Convoy:** this refers to the pathfinder, "*pace car*" and "*technical car*" as well as other vehicles defined and appointed by the Organiser and their crews.
- 1.36 Time Card:** means the document showing the transit times recorded at the CO/TCs.
- 1.37 Website:** means the website <https://ferraritribute.1000miglia.it/>.
- 1.38 Waiting List:** this is the waiting list prepared by the Organiser for the competitors who have applied for entry but have not been accepted by the date of publication of the list of Competitors and cars admitted.

All the times stated in these SR are understood as referring to the Time Zone in use in Italy, namely "*Greenwich Mean Time + 1 hour*" conventionally UTC (GPS) signal | Italy: GMT+1

Value Added Tax (VAT) will be applied on all amounts stated in these SR at a rate of 22% (updated to 25.02.2022). Any variation on this percentage will be notified in the Bulletin and will be enforced in compliance with the laws issued by Italy.

To all legal effects, the Italian version of these SRR will be binding. The English translation of the same is understood as being solely for information purposes.

Article 2 - ORGANISATION

2.1. This event will be run in compliance with the ISC, with the RNS and with other provisions of the ACI Sport, which are understood to regulate whatever is not indicated in the following articles.

2.2. The Organiser states that the competition will have all the necessary administrative authorisations and the required insurance coverage.

2.3. Il Comitato Operativo e di Selezione è composto da

Chairman: Mr. t.b.a.

Vice Chairman: Mr. t.b.a.

Members: Mr. t.b.a.

Mr. t.b.a.

Mr. t.b.a.

Mr. t.b.a.

Mr. t.b.a.

Secretary: Mr. t.b.a.

Head office: 1000 MIGLIA s.r.l. - Via Enzo Ferrari, 4/6 - 25134 Brescia

2.4. OFFICIALS

Chairman of Stewards Mr. t.b.a. (ASN Sport Delegate) licence

Steward Mr. t.b.a. licence

Steward Mr. t.b.a. licence

Stewards secretary Mr. t.b.a. licence

Clerk of the course: Mr. Lucio DE MORI licence 20623

Deputy Clerk of the course: Mr. t.b.a. licence

Event Secretary: Mr. t.b.a. licence

Safety Manager - Route Delegate:

Mr. t.b.a. licence

Chief Medical Officer: Dr. t.b.a. licence

COVID Manager: Mr. t.b.a. licence

Competitor Relations Officers: Mr. t.b.a. licence

Mr. t.b.a. licence

Mr. t.b.a. licence

Mr. t.b.a. licence

Mr. t.b.a. licence

Mr. t.b.a. licence

Judges of fact: The list will be published by a Bulletin

Sporting Operations Inspectors: The list will be published by a Bulletin

Scrutineers: Mr. t.b.a. (ACI Sport delegate) licence

Scrutineers and Scrutineer Assistant:

The list of will be published by a Bulletin

Marshals: of the Automobile Club Brescia and of the Automobile Clubs of other affected Provinces

Time keeping Service: t.b.a.

Head of Timing Service: Mr. t.b.a. licence

Results: Mr. t.b.a. licence

Press Officer: Mr. t.b.a.

Article 3 - PROGRAMME

3.1 Programme before the competition week

Monday 28 February 2022

Date of publication of SRR	Website
Opening date for entries	Competition Secretary

Friday 8 April 2022 at 16:00

Closing Date for entries	Competition Secretary
--------------------------	-----------------------

by Friday 15 April 2022

Communication to entrants of their acceptance, acceptance of the cars	Competition Secretary
Publication of list of Competitors and cars accepted	Website

Thursday 19 May 2022 at 23:59

Final date for communicating the free of charge variation of the data of the drivers not indicated during the entry phase	Competition Secretary
Deadline for the free of charge request of change an entered car	Competition Secretary

Friday 3 June 2022

Deadline for the refund of deposit payment from competitors who have not been accepted and who were not on the waiting list	Competition Secretary
Closing Date for the waiting list	Competition Secretary

Monday 6 June 2022

Briefing of the Organisers and the Clerk of the course	Sent to each entrant
--	----------------------

Tuesday 7 May 2022

Publication of individual verification schedules	Website - ONB
--	---------------

By Saturday 11 June 2022 at 12:00

Publication of individual starting order and times of the 4 Legs	Website – ONB
--	---------------

3.2 Programme for the competition Week

The times shown on the programme for all activities which precede the start of the competition will be confirmed by a board showing the official time of the event, placed in the inspection area by the Timekeeping service.

All crew members who have not reported within the times stated in these SR will be understood as having withdrawn and will not be admitted to the race; no exceptions will be made.

Monday 13 June 2022

10:00 - 19:00 Administrative checks, scrutineering and Road Book distribution (according to individual convocation times communicated)	Brescia, Paddock Expo
--	-----------------------

Tuesday 14 June 2022

10:00 - 19:00 Administrative checks, scrutineering and Road Book distribution (according to individual convocation times communicated)	Brescia, Paddock Expo
--	-----------------------

Wednesday 15 June 2022

07:30 - 08:30 Administrative checks, scrutineering and Road Book distribution (according to individual convocation times communicated) Briefing of the Organiser and Clerk of the course (recorded)	Brescia, Paddock Expo
07:30 - 08:30 Entry of Crews on the "Waiting List"	Brescia, Paddock Expo
09:00 - 09:45 Administrative checks and scrutineering, for Crews on the "Waiting List"	Brescia, Paddock Expo
11:00 Briefing with the Clerk of the Course	Desenzano d/G, ...TBA...

Ferrari Tribute 1000 Miglia 2022 | Special Race Regulations

11:30	Publication of list of competitors and accepted cars	Website - ONB
from 13:00	Lining up for start of Leg 1	Desenzano d/G, TBA...
13:30	Departure of first car – Leg 1	Desenzano d/G, TBA...
20:45	Arrival of first car – Leg 1	Cervia, Mi.Ma.

Thursday 16 June 2022

06:30	Publication of partial classification of Leg 1	Website - ONB
from 06:30	Lining up for start of Leg 2 <i>(minimum 30' before the individual starting time)</i>	Rimini, ...TBA.....
07:00	Departure of first car – Leg 2	Rimini, ...TBA.....
21:00	Arrival of first car – Leg 2	Roma, Villa Borghese

Friday 17 June 2022

05:00	Publication of partial classification of Leg 2	Website - ONB
from 05:00	Lining up for start of Leg 3 <i>(minimum 30' before the individual starting time)</i>	Roma, Villa Borghese
05:30	Departure of first car - Leg 3	Roma, Villa Borghese
20:45	Arrival of first car - Leg 3	Salsomaggiore Terme

Saturday 18 June 2022

07:00	Publication of partial classification of Leg 3	Website – ONB
from 07:00	Lining up for start of Leg 4 <i>(minimum 30' before the individual start time)</i>	Salsomaggiore Terme
07:30	Departure of first car - Leg 4	Salsomaggiore Terme
15:30	Arrival of first car - Leg 4 and passage on the ramp	Brescia, IVECO Park
from 16:00	Mandatory Passage on the ramp	Brescia, Viale Venezia
17:00	Publication of final classification	Website – ONB
17:30	Prize giving ceremony	Brescia, Piazza Loggia

Competition Headquarters, Competition Secretary and Paddock

Brixia Expo - Fiera di Brescia, Via Caprera 5 - 25125 Brescia

Leg Secretaries

Rimini – Grand Hotel Rimini, Viale Giovanni Battista Ramusio, 1
from 19 to 24:00 of Wednesday 15 June 2022

Rome – The Westin Excelsior, via Vittorio Veneto 125 – Hall
from 18:00 to 24:00 of Thursday 16 June 2022

Salsomaggiore Terme – Grand Hotel Salsomaggiore, via della Rosa, 1
from 18:30 to 24:00 of Friday 17 June 2022

Official Notice Board (ONB)

Brescia (competition Headquarters), Leg Secretaries and Website

Website

www.ferrartribute.1000miglia.it

Synchronization of the Organisation's time-keeping systems:

UTC (GPS) signal | Italia: GMT+1

Article 4 - RACE

The Organiser 1000 MIGLIA s.r.l. announce and organise, as from Monday 13 June to Saturday 18 June 2022 a Classic Regularity Competition for Historical Cars, Grande Evento, to be known as:

FERRARI TRIBUTE 1000 MIGLIA 2022

Article 5 - ROUTE

The competition route will have an overall length of Km 1.740,50 and will be described in the Itinerary Table (TDT) attached to these SRR, and of which it is an integral part, and in the Road Book. The TDT will also show the methods of carrying out the timed Legs for classification.

There will be 17 Time Controls (CO/TC), 97 Time Trials (PC/TT), 8 Average Trials (PM/AT) with a total of 23 readings and 19 Passage Controls (CT/PC).

The start and finish of the competition are scheduled at the places and times indicated in the competition Programme.

The competition will take place on roads open to traffic, barring any limitations set by the competent Administration Authorities, with average speeds not exceeding 50 Km/h.

Any route changes due to road works, or temporary obstructions, will be notified with Bulletins directly on site, if possible, by the Police or by persons appointed by the organisation.

Article 6 - COMPETITORS, DRIVERS AND CARS ALLOWED

6.1 COMPETITORS AND DRIVERS ALLOWED

- 6.1.1** Competitors, and crew members must hold a valid ACI Sport Competitor/Driver's Licence or a valid regularity licence (for Italian competitors/Drivers) or a valid Co-driver or Competitor/Driver's licence, issued by their ASN (for foreign competitors/drivers of International or National - with authorisation to compete in the event) valid in Italy.
- 6.1.2** At least one of the two crew members must be in possession of an Italian driving licence during all the legs of the race. Crew members without an Italian driving licence, or in any case valid in Italy, must also present, if necessary, an international driving licence, valid in Italy.
- 6.1.3** For each vehicle, a competitor may enter a crew comprising of 2 persons, who must be on board the vehicle during all phases of the race.
- 6.1.4** A competitor who is a physical entity, entering a vehicle for the competition must always be on board the vehicle throughout the race. In the case of a Competitor being a legal person, he/she may enter more than one car and appoint a Crew for each one, but it is expressly forbidden to exchange Crews between the entered cars.
- 6.1.5** A competitor who is a physical entity, entering a vehicle for the competition must always be on board the vehicle throughout the race.
- 6.1.6** During all the phases of the competition the vehicle may be driven only by crew members who have been verified and accepted with that specific vehicle.
- 6.1.7** Members of foreign crews who do not have a valid Competitor/Driver's licence, issued by their NSA, may be issued an ACI Sport regularity licence during the pre-race verification, valid only for the Ferrari Tribute 1000 Miglia 2022 race, upon payment of the related fees.
- 6.1.8** Crew members below the age of 14 (i.e. those who have not yet turned 14 at the date of the end of the checks) and older than 85 years of age (i.e. those who will have already turned 86 as the end of the race) will not be accepted.
- 6.1.9** Passengers will not be allowed, that is, crew members who have not been verified and who are not in possession of the requirements of Articles 6.1.1, 6.1.2 and 6.1.8 of these SR.
- 6.1.10** The substitution of a competitor after the close of entries, is not permitted.
Crew members may be replaced:

Ferrari Tribute 1000 Miglia 2022 | Special Race Regulations

- a. with the authorisation of the Organiser, up to the start of administrative checks;
- b. with the authorisation of the Stewards, from the start of checks until publication of list of admitted competitors and crews and of the accepted competition cars.

The substitution of two members of the crew is subject to the approval of the Organiser, in accordance with the ASN of the organiser.

Until 11:59 p.m. on Thursday May 19th 2022, the first replacement of both crew members or the inclusion of names not previously communicated are free of charge. From Friday May 20st 2020 each replacement or insertion of a crew member will have to be paid for an amount of € 366,00 (equal to € 300,00 + VAT), as administration fees. If payment is not made, the request for replacement will not be considered valid.

It will not be possible to replace both crew members if the car has already been replaced.

6.2 DOCUMENTATION REQUIRED IN ORDER TO OBTAIN A SPORTS LICENCE AT THE ADMINISTRATIVE CHECKS

The maximum age for obtaining the regularity licence, whether daily for foreigners or annual for Italians, is 75 years for both sexes. The possibility of raising the maximum age of competitive activity up to 85 years is allowed. Below is the list of the documentation necessary for obtaining the prescribed licence:

a) Drivers of Italian nationality UNDER 75 at the date of the closure of administrative verification

In order to issue/renew the licence, the following documents are required:

- medical certificate for non-competitive sports activities (Facsimile in Appendix 1 to these SR) obtained in Italy as per current regulations;
- driving licence (for both crew members);
- ACI membership card (for those not in good standing with the association, it will be possible to renew/issue this on-site by communicating the data of the car used every day, or the licence plate number of the historic car entered in the competition, depending on the type of ACI Service required).

b) Drivers of Italian nationality OVER 75 at the date of the closure of administrative verification

In order to issue/renew the licence, the following documents are required:

- medical certificate for competitive sports activities (Facsimile in Appendix 2 to these SR) obtained in Italy as per current regulations;
- driving licence (for both crew members);
- ACI membership card (for those not in good standing with the association, it will be possible to renew/issue this on-site by communicating the data of the car used every day, or the licence plate number of the historic car entered in the competition, depending on the type of ACI Service required).

c) Drivers not of Italian nationality UNDER 75 at the date of the closure of administrative verification

In order to issue/renew the licence, the following documents are required:

- medical certificate for non-competitive sports activities (Facsimile in Appendix 1 to these SR) obtained in Italy as per current regulations; alternatively, a medical certificate of good health issued abroad, written in English, signed and stamped by a doctor.
- self-certification stating you do not hold other valid licences issued by other ASN and to not having incurred disciplinary sanctions;
- national and international driving licence (both crew members).

d) Drivers not of Italian nationality OVER 75 at the date of the closure of administrative verification

In order to issue/renew the licence, the following documents are required:

- medical certificate for competitive sports activities (Facsimile in Appendix 2 to these SR) obtained in Italy as per current regulations; alternatively, a medical certificate of good health issued abroad, written in English, signed and stamped by a doctor.
- self-certification to not possessing other valid licences issued by other ASN and to not having incurred disciplinary sanctions;
- national and international driving licence (both crew members).

6.3 ACCEPTED CARS

6.3.1 Up to 100 vehicles, exclusively of the FERRARI make, will be accepted. Of these, a maximum of 35, defined as "historic" (manufactured from the origins to 1990, only if not eligible for 1000 Miglia), will be allowed. The remaining cars, defined as "modern", manufactured from 1991 to now, will be accepted only if they belong to the following models or have the following types of engine:

1. models: GTO, F40, F50, Enzo Ferrari, LaFerrari, F60 America, Sergio, LaFerrari aperta, (category: Supercar, Limited Edition)

Ferrari Tribute 1000 Miglia 2022 | Special Race Regulations

2. models: F512M, 550 Barchetta Pininfarina, Superamerica, 612 Sessanta, 599 GTO, SA Aperta, F12 TdF, Challenge Stradale, 430Scuderia, Scuderia 16M, 458 Speciale, 458 Speciale A, 488 Pista, 488 Pista Spider, Monza SP1, Monza SP2 (Category: Special Series)
3. 8-cylinder engines
4. 12-cylinder engines

Every Ferrari car that undergoes unauthorized modifications by the parent company can no longer be considered a "Ferrari". The use of Ferrari badges on modified and / or altered cars after their placing on the market constitutes a violation of the Ferrari brands, sanctioned by the relevant regulations, as well as damaging the prestige of the same brands, the Ferrari name and the original cars of our Clientele.

For this reason, the modified Ferrari cars can not under any circumstances participate in the event, or any other activity promoted, organized or supported by Ferrari itself.

6.3.2 "MODERN" VEHICLES – BUILT FROM 1991

The accepted vehicles will be placed into the following groupings:

- Grouping A: 8-cylinder engines
- Grouping B: 12-cylinder engines
- Grouping C: Special Series, Limited Edition, Supercars

Inclusion of vehicles into Grouping C excludes them from Groupings A and B.

Vehicles must be fitted exclusively with tyres approved for road use; in its original configuration, namely that provided by the manufacturer for normal road use which can also include accessories to embellish or improve comfort.

The cars may be without sports documents.

6.3.3 "HISTORIC" VEHICLES – FROM THE ORIGINS TO 1990

Accepted vehicles will be divided into the following groupings:

- Grouping D: vehicles built from the origins to 31/12/1969
- Grouping E: vehicles built from 01/01/1970 to 31/12/1990

The certificate of authenticity of the entered vehicle, issued by FERRARI CLASSIC, or a copy of the request for certification, must be enclosed with the registration form.

Vehicles must also be accompanied by one of the following valid sporting documents:

- ACI-CSAI Regularity of Historic Cars card;
- HTP FIA (Historic Technical Passport FIA);
- HTP CSAI (Historic Technical Passport CSAI);
- Certificate of registration to ACI Storico Register;
- ASI homologation or identity certificate;
- Certificate of registration to the AAVS National Historic Register;
- FIA historic car regularity pass;
- FIVA Identity Card.

Regardless of the sport document presented for admission to the races, the configuration of the cars must conform to the criteria of the ACI Sport Regulation.

Cars entered by foreign crews, but not having the documents listed in this article, may be admitted with a declaration of conformity to the sports regulations, issued by the same competitors, given to and countersigned by the organisers.

6.3.4 The cars entered must comply with the periodic revision of the vehicles if required and in accordance with the provisions of the laws of the country of registration. If the country of registration does not provide for the periodic revision of the cars, the competitor must produce a self-declaration in which he must declare the lack of need for revision according to the laws of the country of registration and consequently, he will declare to be able to circulate in his own country of origin having undergone all the technical checks to demonstrate the perfect efficiency of the car and all its devices. In the absence of this document the crew will not be able to pass the administrative checks.

6.3.5 Le vetture dovranno inoltre possedere tutti i requisiti per poter circolare entro il territorio italiano.

6.4 REPLACEMENT OF A COMPETITION CAR

6.4.1 CONDITIONS FOR SUBSTITUTION

Until 23:59 on Thursday May 19th 2022, the replacement of a car accepted or inserted in the waiting list is allowed. A car accepted or included in the Waiting List may be replaced, subject to payment according to the provisions of article 6.4.2 below and subject to the approval of the Organiser, only with another car that meets all the requirements of these SRR.

In case of non-acceptance of the entry, in order to obtain the acceptance, the Competitor will not be able to request the replacement of the car.

It will not be possible to replace the car if both crew members have already been replaced.

6.4.2 REQUIREMENTS FOR REQUESTING THE SUBSTITUTION OF A COMPETITION CAR

In order to request the replacement of a car, the Competitor must send the appropriate form made available to the Organiser on the Website by e-mail to participants@1000miglia.it with a request for acceptance by the receiver and followed by confirmation of receipt by the receiver attaching the documentation in the form. Competitors provided with certified e-mail (PEC) must send the abovementioned notice to the PEC address: 1000miglia@legalmail.it.

The substitution of the competition car requires the mandatory payment of € 2.440,00 (i.e. € 2000,00 + VAT 22%) for administrative fees, payable to the IBAN number stated on the car substitution form. In the absence of such payment, the request for substitution will not be taken into consideration. The Organiser will contact the competitor within 10 days from receipt of the request for substitution, accompanied by the bank transfer.

6.5 The use of a temporary number plate is always prohibited, under penalty of immediate exclusion.

6.6 The following are always prohibited, subject to a penalty which may include exclusion, at the Stewards discretion:

- a) the installation and use of any protrusion from the bodywork, not envisaged by the Manufacturer, which has the purpose of sighting the intermediate split lines;
- b) installing or implementing viewfinders with adhesive material, inside or outside the vehicle, having dimensions larger than 15 cm in length and 2 cm in width;
- c) the presence of adhesive viewfinders on competition number plates, on the Organiser's advertising stickers and on competition number plates.

Article 7 – COMPETITION NUMBER AND STARTING ORDER

7.1 The assignment of competition Numbers, valid also for drawing up the Starting Order in relation to the increasing order of the numbers assigned, excepting for specific organisational requirements, will comply with the following criteria:

- cars in increasing order of year of manufacture.

7.2 Vehicles in the waiting list (Article 8.12) will leave according the competition number assigned by the organiser who will, as far as possible, comply with the criteria stated in the previous points of this article.

ARTICLE 8 - ENTRIES

8.1 Presentation of the entry form does not give the right to participate in the competition as the organiser will select the requests and accept entries in his unquestionable judgement.

The organisers will not be required to motivate the reason for exclusion, nor will the said exclusion allow for the request for damages and/or refund of expenses, excepting for the return of the deposit (Art. 8.3 of these SR).

8.2 METHODS OF ENTRY AND WITHDRAWAL OF ENTRY

Entry applications may only be submitted via the Website.

The presentation date of each competitor's entry application coincides with the date on which the sum provided for in art. 8.3 below is credited to the bank account in the name of the Organiser. Entry must be formalized according to the days and times indicated in the Programme of these SRR.

Acceptance of the entry application will be announced to the Competitor according to the terms and conditions set out in these SRR.

8.3 ENTRY GUARANTEE DEPOSIT

8.3.1 Payment of Euro 12.200,00e Euro 14.640,00 depending on the selected service package, valid as a deposit for entry of the car and team must be made in one of the following ways:

- a) by Credit Card (only VISA - MASTERCARD) by 23:59 (GMT+1) on Friday 8 April 2022;
- b) by bank transfer to the coordinates indicated in the entry form, with maximum credit value on the 1000 Miglia S.r.l. current account by 23:59 (GMT+1) on Friday 8 April 2022.

For the entry to be valid, the crediting date onto the current account of 1000 Miglia is considered and not that of the payment mandate.

8.4 ACCEPTABILITY OF ENTRY REQUESTS

Entry requests must be complete with all the necessary documentation, also photographic, accompanied by the greatest number of documents attesting the history of the registered vehicle, and the payment of the deposit.

Failure to pay the deposit means the request for entry will not be taken into consideration.

Requests which are untrue, incomplete, without documentation or with amounts owing to the organisation, will not be taken into consideration.

The organisation reserves the right not to accept vehicles whose drivers have been penalised in previous editions of the "1000 Miglia".

The organizer also reserves the right not to accept the entry of drivers who for three times during the previous year's race committed infractions of exceeding the speed limit set by the authorities in charge and detected by the Speed Test prepared by the Management Race.

8.5 ACCEPTANCE OF ENTRY

By Friday 16 April 2021, each team will be able to verify online, inside its own reserved area, whether or not the entry for the competition has been accepted. Confirmation will nonetheless be sent also to the e-mail address indicated in the relative area of the entry form.

To complete entry it will be necessary to enter the Bank details in the relative section of the on-line form, for the return of the fee, if necessary.

8.6 FINALISING ENTRY

Entry is understood as being finalised only on acceptance of the entry request by the organiser and to the allocation of the sum paid as a deposit in the sum paid as an entry fee.

After the car has been accepted at the event, 1000 Miglia Srl will issue a regular invoice, using the data requested during the entry phase.

By presenting the request for entry, the applicant authorises the organiser to consider the amount paid previously as a deposit, as an entry fee in the case of acceptance of the request for entry.

8.7 ENTRY FEE

The following entry fees are envisaged:

8.7.1 BASIC ENTRY IN DOUBLE ROOM

The basic entry fee in a double room amounts to Euro 10,000.00 plus 22% VAT (total Euro 12,200.00) and includes:

- a) Participation in the competition after selection of the car:
 - kit of documents and technical materials provided;
 - standard passes;
 - 2 Welcome bags.
- b) Hospitality for a crew of two persons, including:
 - 3 nights in a double room (not less than 4 stars) with breakfasts;
 - 4 light buffet lunches per person;
 - 3 light dinners per person;
 - Ferrari Tribute Prize giving ceremony for driver and co-driver
- c) Services included in the entry:
 - Pre check-in Service in the hotels in the race leg (subject to sending of the credit card and passport)
 - 4 Admissions to the Paddocks (including driver and co-driver);
 - Possibility to purchase additional service packages.

8.10.2 GOLD ENTRY IN DOUBLE ROOM

The gold entry fee in a double room amounts to Euro 12,000.00 plus 22% VAT (total Euro 14,640.00) and includes:

- a) Participation in the competition after selection of the car:
 - kit of documents and technical materials provided;
 - "Gold" passes;
 - 2 Welcome bags with specific Merchandising.
- b) Hospitality for a crew of two persons, including:
 - 5 nights in a double room (not less than 4 stars) with breakfasts;
 - 4 light buffet lunches per person;
 - 3 light dinners per person;
 - Ferrari Tribute Prize giving ceremony for driver and co-driver and 2 extra invitations.
- c) Services included in the entry:
 - 4 Admissions to the Paddocks (including driver and co-driver);
 - Pre check-in Service in the hotels in the race leg (subject to sending of the credit card and passport by 16th May 2022)
 - Possibility to purchase additional service packages;

8.8 REFUND OF THE ENTRY FEE FOR CREWS NOT ACCEPTED

In the case of non-acceptance and/or non-inclusion on the waiting list of a car by the organiser, the deposit will be refunded by bank transfer or accredited on the credit card, by Friday 3 June 2022.

8.9 HOW TO WITHDRAW THE APPLICATION FORM OR ENTRY

In all cases:

- the request for withdrawal of the entry application, i.e. the entry, must be sent by e-mail to participants@1000miglia.it with a request for acceptance by the recipient and followed by confirmation of receipt by the recipient himself. Competitors provided with certified e-mail (PEC) must send the abovementioned notice to the PEC address: 1000miglia@legalmail.it;
- if due, the refund of the entry fees will take place within 60 (sixty) days following the announcement date of the withdrawal.

8.10 REFUND OF THE ENTRY FEE IN CASE OF WITHDRAWAL OF THE ENTRY APPLICATION OR THE ACCEPTED ENTRY

Except as otherwise provided in Article 8.18 below, in the event of withdrawal, for any reason, of the entry application or the accepted entry by a Competitor, the entry fees shall be refunded only as follows:

From: opening date for entries To: closing date for entries	The fee paid as deposit by the Competitor shall be entirely refunded to the latter, net of administrative charges in the amount of Euros 150.00 plus VAT equal to 22%;
From the day following the closing date for entries To: publication of list of Competitors and cars accepted	The fee paid as a deposit by the Competitor shall be entirely refunded to the latter, net of a penalty equal to Euro 1,000.00 (VAT exempt pursuant to article 15, paragraph 1, Italian Presidential Decree 633/72);
From the day following the publication of the list of Competitors and cars accepted To: Tuesday 28 April	The entry fee shall be refunded to the extent of 50% plus VAT;
From: Friday 29 April To: Tuesday 19 May	The entry fee shall be refunded to the extent of 75% plus VAT;
From: Friday 21 May	The entry fee shall not be refunded

8.11 FAILURE TO PASS ADMINISTRATIVE CHECKS

In the case of failure to pass the administrative checks and/or scrutineering, the competitor will not have the right to the refund of the entry fee paid, but will retain the right to make use of the hospitality envisaged for the team and any gifts and gadgets distributed directly by the sponsors, as per Article 8.7 et seq. of these SSR. This right shall be guaranteed only if the competitor or a crewmember with proxy signed by the competitor are present at the pre-competition administrative checks. Therefore, if Competitors or drivers authorised by the same, are not present at the pre-competition checks, they will not be entitled to the refund of the entry fee, nor will they be allowed to enjoy the hospitality provided for the crew or any benefit

or facilities reserved to the participants.

8.12 WAITING LIST

The "Waiting List" is an instrument that allows the competitors entered for the event, but not accepted by the Organiser by the publication of the list of Competitors and cars accepted, to participate in the competition by replacing crews that have withdrawn or have not passed the checks for any reason.

At the presentation of the request for entry, every competitor must state his acceptance to be placed on the "Waiting list".

The waiting list will be made up of the cars that:

- a) satisfy all eligibility requirements, as contained in these SR;
- b) have not been accepted by the publication of the list of Competitors and cars accepted;
- c) belong to competitors who have provided their willingness to be part of such list.

Should a competitor accepted for the competition as from publication of the list of competitors and cars admitted notify his withdrawal from the competition, the organiser, at his sole discretion, will select one.

Competitors included in the Waiting List will have the possibility to accept or refuse the proposal by replying to participants@1000miglia.it within 72 hours from the announcement. Competitors provided with certified e-mail (PEC) must send the abovementioned notice to the PEC address: 1000miglia@legalmail.it.

Acceptance by the Organisation will allow the team to be registered for the competition in compliance with Article 8.6 of these SR.

In case of non-acceptance by the Competitor of the proposal for participation, the amount paid by the Competitor as a guarantee deposit will be refunded in full net of secretarial costs of Euro 400,00 plus 22% VAT.

8.13 LIST OF CARS ON THE "WAITING LIST"

There are no lists for the cars on the waiting list. The replacement of crews that have withdrawn will be at the unquestionable discretion of the organiser.

8.14 CLOSURE OF THE "WAITING LIST"

The "Waiting list" will close on Friday 3rd June 2022 at 23:59.

By the said date, the Organiser will inform those teams on the "Waiting list" whether they have been accepted for the race, or not, by e-mail directly to the address stated in the relative section of entry form.

8.14.1 The organiser has the right to contact competitors on the "Waiting List" in the case of withdrawal, from Saturday 4th June to Tuesday 4th June 2022.

Competitors included in the Waiting List will have the possibility to accept or refuse the proposal by replying to participants@1000miglia.it within 24 hours from the announcement. Competitors provided with certified e-mail (PEC) must send the abovementioned notice to the PEC address: 1000miglia@legalmail.it.

Acceptance by the Organizer will result in the Crew entering the race in accordance with and for the purposes of Article 8.6 of these SRR.

In case of non-acceptance by the Competitor of the proposal for participation, the amount paid by the Competitor as a guarantee deposit will be refunded in full.

8.15 ADMISSION TO THE RACE DURING THE PRE-RACE VERIFICATION

Albeit without any guarantee of participating, competitors on the "Waiting list" will be able to be present at administrative checks on Wednesday 15th June 2022, from 07:30 to 08:30. After having entered, they have the possibility of being admitted to the competition after scrutineering, at the unquestionable judgement and discretion of the organiser.

Acceptance can only take place in replacement of entered crews who have not passed scrutineering.

The crews coming from the "Waiting List" will not be entitled to any benefit or facilitation recognized to the participants, they will be entitled exclusively to the services related to the basic package as per art. 8.7.1). If the competitors accepted from the waiting list had paid the entry fee of the gold package, the partial refund of the security deposit will take place within 60 days following the date of withdrawal and in any case no later than Friday 29th July 2022.

Acceptance will require the entry of the crew to the competition, pursuant to and for the purposes of Article

8.6 of these SR.

8.15.1 The competitors who replace others during the scrutineering phase will be selected from among the registered crews, based on the following priority criteria:

- a) in substituting, priority will be given to a vehicle from the same period as the one substituted;
- b) with equal requisites, the competitor coming from further away will be selected.

8.16 NOTIFICATION OF WITHDRAWAL OF ENTERED CARS ON THE "WAITING LIST"

The withdrawal of the entry application by the competitor included in the Waiting List must be sent by e-mail to participants@1000miglia.it with a request for acceptance by the receiver and followed by confirmation of receipt by the receiver. Competitors with certified e-mail (PEC) must send the abovementioned notice to the PEC address 1000miglia@legalmail.it.

8.17 REFUND OF DEPOSIT FOR VEHICLES ON THE "WAITING LIST"

The refund of the deposit in the case of withdrawal by a competitor of a vehicle on the waiting list, will only occur in compliance with what is stated in Article 8.9 of these SR, applying administrative fees of Euro 400,00 plus VAT.

If owed, the deposit fee will be refunded within 60 days from the date of notification of the withdrawal, and nonetheless within and no later than Friday 29th July 2022.

It remains firm that competitors who do not withdraw and are not selected from the "Waiting List" have the right to be refunded in full for the amount paid by bank transfer or accredited on their credit card by Friday 29th June 2022.

8.18 RESTRICTIONS ON ENTRY INTO ITALY OR EXIT FROM THE AREA OF RESIDENCE

Persons, as the defined below in this Article, who are resident:

- 1. in countries from which entering Italy is barred by provision of Italian or such country's authorities in relation to the COVID-19 health emergency;
- 2. in countries from which exit is precluded by order of its authorities in relation to the COVID-19 health emergency;
- 3. on the Italian territory, in an area (e.g. Region, Province, Municipality) from which exit is forbidden by order of the Italian authorities in relation to the COVID-19 health emergency;

during the period from the closing date for entry applications to 11st May, who intend to withdraw from the Race, shall send their withdrawal by e-mail to participants@1000miglia.it, attaching a copy of the provision of the competent Authority, no later than 11st May at 23:59, in order to – and as a way of exception to the provisions set forth in Article 8.10, alternatively:

- a) seek the refund of the fees paid as a deposit net of administrative charges in the amount of Euro 150.00 plus VAT equal to 22%; or
- b) keep the fees paid in the Organiser's account as pre-payment of the entry fees for the next edition of the race, without prejudice to any possible potential economic integration in case of increase of the entry fees, and provided that a new application for the next edition of the race shall be submitted.

Failing to send the withdrawal within 12nd May, or in case of communication of withdrawal after that date should the restrictions persist, or in the event that one of the cases described in this article should occur after April 9, the following provisions shall apply:

Communication of preclusion received by 1000 Miglia in the period:	Withdrawal conditions
From: Thursday 12 May To: Wednesday 25 May	The fee paid by the Competitor as a deposit shall be entirely refunded to the latter net of a deduction as administrative and management costs equal to 10% of the fee paid plus VAT at 22%
From: Thursday 26 May To: Friday 3 June	The entry fee shall be refunded to the extent of 50% plus VAT;
From: Saturday 4 June	The entry fee shall not be refunded

For the purposes of the application of the provisions set forth in this Article, "person" means alternatively:

- a. the Competitor being part of a Crew;
- b. the owner (if natural person) of the car part of the Crew;
- c. both the Drivers indicated during the entry phase.

8.19 POSTPONEMENT OF THE EVENT DUE TO COVID-19 PANDEMIC OR FORCE MAJEURE

Organiser shall be entitled, at any time and at its sole discretion, to postpone the Race if the health emergency caused by Covid-19 persists, or for extraordinary and unexpected events beyond its control such as, including but not limited to, new epidemics, measures issued by the authorities, earthquakes, floods, sudden climatic changes which prevent, in whole or in part, the performance of the Race.

Any request for withdrawal shall be subject to the provisions set forth in Article 8.13 according to the new deadlines that will be communicated.

8.20 CANCELLATION OR SUSPENSION OF THE EVENT DUE TO COVID-19 PANDEMIC OR FORCE MAJEURE

Organiser shall be entitled, at any time and at its sole discretion, to cancel and/or suspend the Race if the health emergency caused by Covid-19 persists, or for extraordinary and unexpected events beyond its control such as, including but not limited to, new epidemics, measures issued by the authorities, earthquakes, floods, sudden climatic changes which prevent, in whole or in part, the Race.

In case of cancellation or suspension of the Race, the Organiser shall refund the entry fees as follows:

From: opening date for entries To: closing date for entries	The fee paid as a deposit by the Competitor shall be entirely refunded to the latter;
From the day following the closing date for entries To: Wednesday 4 May	The fee paid as a deposit by the Competitor shall be entirely refunded to the latter net of administrative charges in the amount of Euros 250.00 plus V.A.T. equal to 22%;
From: Thursday 5 May To: Wednesday 25 May	The fee paid as a deposit by the Competitor shall be entirely refunded to the latter net of a deduction as administrative and management costs equal to 10% of the fee paid plus VAT at 22%
From: Thursday 26 May To: Friday 3 June	The fee paid as a deposit by the Competitor shall be entirely refunded to the latter net of a deduction as administrative and management costs equal to 20% of the fee paid plus VAT at 22%
From: Saturday 4 June To: Sunday 12 June	The entry fee shall be refunded to the extent of 50% plus VAT equal to 22%;
From: Monday 13 June	The entry fee shall not be refunded

In case of postponement of the race, the aforementioned time limits will be extended.

Competitors included in the Waiting List shall be subject to the provisions of Article 8.17; Competitors who have not been accepted shall be subject to the provisions of Article 8.8 of these SRR.

8.21 HEALTH EMERGENCY COVID-19 - FORCE MAJEURE

The Competitor, having taken note of the current exceptional situation, in Italy and in the world, due to COVID-19 pandemic and of the fact that it is currently not possible to predict the potential developments of the pandemic itself, nor of the possible emergency (or otherwise) measures which may from time to time be adopted by the competent authorities in relation to the aforementioned pandemic, with the execution of these SRR expressly accepts and agrees as follows:

(i) the Organiser has the right to postpone, cancel or suspend the Race should this be necessary or appropriate, prior or during the Race itself, due to reasons arising out from the COVID-19 pandemic or other and new extraordinary and unforeseeable events that make its organization impossible or excessively difficult;

(ii) to comply with any and all provisions, regulations, guidelines, specifications, etc. which may be issued from time to time by any Italian Authority, or even by the Organiser, regarding the COVID-19 pandemic and/or the prevention of related infections.

Article 9 - GENERAL OBLIGATIONS

9.1 ADMINISTRATIVE CHECKS

Competitors and drivers must be present in person and with the accepted car, failure to do so will imply the impossibility of passing the checks and therefore of participating in the race, in the ways and means established in the programme. The Sports Inspectors and Road Traffic Police will undertake the following checks and formalities:

- a) checking of mandatory documents for competitors and drivers to be presented in original copy:
 - valid driving license, national and international;
 - sports licence of the nation of belonging or Italian daily licence;
 - medical certificate (Article 6.2 of these SR);
 - valid competition car insurance;
 - competition car registration papers.
 - possible declaration of non-necessity of periodic revision of the vehicle according to the laws of the country of registration of the vehicle.
- b) hand out and apply the Personal Identification Device (CPI) described in Article 9.2 of these SR;
- c) sign, for acceptance, the check forms drawn up by the organiser and the Road Traffic Police;
- d) listening to or acknowledgement of the briefing by the organiser and the Clerk of the course on the methods and procedures of the race, signing for acceptance of the contents.

The procedures for carrying out the administrative checks may be totally or partially dematerialised according to the anti COVID regulations prepared by the ASN and national or territorial government Bodies.

9.2 PERSONAL IDENTIFICATION DEVICE (CPI)

During the administrative checks, a Personal Identification Device (CPI) will be applied to each driver, in order to identify clearly the participant for the entire duration of the event.

The staff delegated by the organiser will be responsible for the application of this device and this cannot be refused by the driver.

The device cannot be ceded and cannot be removed until the end of the competition on penalty of exclusion from the race.

The exhibition of the (CPI) can be requested by Officials or by escorting Road Traffic Police, at any moment. The absence of the sticker can result in the exclusion of the crew and the car from the race.

In the case of breakage or loss of the (CPI) the driver must first notify it to the first Competitor Relations Officer he finds along the route.

9.2.1 Only members of crews who have passed the pre-competition administrative checks can participate in the competition. No exchanges of authorised drivers are allowed between cars in the race.

Should persons other than those who have passed the pre-competition administrative checks be found on board a competition car during the race, except for the transport of an injured person, the car and its driver will immediately be excluded from the race; this also does not exclude further penalties to be decided at the discretion of the Stewards.

9.3 COMPETITION NUMBER STICKERS

At the administrative checks, each competitor will receive a Sticker Kit consisting of:

- 3 round number holder stickers, with the competition number and the Organizer's advertising;
- 2 series of pre-spaced fluorescent competition numbers.

9.3.1 APPLYING THE COMPETITION STICKERS TO THE CARS

Cars must be presented for technical checks with all the kit stickers mentioned in Article 9.3 of these SR already applied, according to the following instructions:

- a) 1 round number holder sticker for each side of the competition car on the front doors (in cars with doors) or on the front sides (on cars without doors or with small doors);
- b) 1 round number holder sticker on the front bonnet of the competition car;
- c) 1 pre-spaced fluorescent number on the front windshield positioned to allow it to be seen when looking at the front part of the competition car;
- d) 1 pre-spaced fluorescent number on the rear window: should this not be possible the sticker must be applied on the rear boot in such a way as to allow it to be visible looking at the back of the competition car;

The guide layout is provided attached to these SR, for the correct positioning of the competition numbers (Appendix 3).

Should it not be possible to apply all three of the round number holder stickers that are distributed, on the cars due to lack of space, it will be possible to apply only 2 stickers. In this case, the third sticker must be returned to the Organisation at the technical check, failure to do so could result in exclusion from the race.

9.4 SCRUTINEERING

After having passed all the administrative checks, the crews must submit the cars to scrutineering, in the ways and times stated in the programme. Failure to do so will lead to the cars being excluded from the race. Checks will be as follows.

- a) check of the correct positioning of the stickers in compliance with Articles 9.3.1 of these SR and check of the sound and light signals suitable for travelling on the road;
- b) check of the following documents, only for historic cars, to be presented as originals:
 - FIVA International Identity Card and/or FIA Heritage Certificate and/or valid ACI Sport Fiche, and/or ACI Storico Certificate and/or HTPFIA concerning the competition car, all valid;
 - check that notified data correspond with registration data (year of manufacture and chassis number);
- c) placing of safety equipment as per Article 9.5 of these SR.

9.5 SAFETY EQUIPMENT

The GPS tracker equipment supplied by the organiser must remain installed on the competition car for the entire duration of the race. The equipment must be returned to the CO/TC at the final arrival.

The device will be pre-installed during the scrutineering by company engineers (a strip of Velcro will be applied on the vehicle to fix the device) and all necessary information as well as a use manual for the device will be provided, as well as a release form for the use of data recorded on the device itself.

The "GPS Tracker" will track compliance to the route of the competition by the team and will also record the speed of the car. Recorded data will be available to the competition Directors and Stewards in order for them to take disciplinary action against the competitors who have broken the Road Safety Rules and the competition regulations, aside from any other provisions that could be taken by Police Officers who have detected an infringement of the law. Data could be made available following a request by the legal authorities.

In the case of loss or malfunction of the device, the competitor will notify this to the Competitor Relations Officer at every T.C. or those responsible for technical devices present at every lunch break and every arrival/start of each Leg.

In the case of withdrawal of a competitor along the route of the various Legs, the device will be returned to the Competitor Relations Officers or to the persons responsible for this in the Technical Support Convoy (Technical Car and Pace Car).

9.6 OBLIGATIONS OF COMPETITORS - RULES OF CONDUCT

Throughout the event, drivers must drive prudently and carefully, scrupulously respect the Italian Road Traffic Law and instructions given by the Clerk of the course and by Officials.

The Officials - those in Charge (Article 2.4 of these SR) positioned in the Technical Support convoy (teams in the Front Car, Pace Car and Technical Car), Road Traffic Police Officers will notify violations and offences of the Regulations, and the Instructions stated above.

In the case of infringements, the Clerk of the course will notify the Stewards who will apply the following penalties:

- first offence: 1.000 negative penalty points;
- second offence: 12.000 negative penalty points;

Depending on the seriousness of the offence, the Stewards will apply the penalties up to exclusion from the event, even after only one offense.

In each Leg, the CoC can undertake speed checks on all the cars in the race. The Officials along the route as well as all the cars in the Technical Support convoy and Road Traffic Police Officers will also be responsible for supervising the conduct of the competitors and their service and team vehicles, notifying the Clerk of the course of any offence but without taking any independent decisions.

Also, Road Traffic Police Officers and local Police Members in the relative areas can notify the CoC of any offences by competitors and their service and team vehicles.

Driving behaviour should always be prudent for oneself, for Officials, and especially for spectators.

Each competitor is always responsible also for the behaviour of their service and team vehicles, which must necessarily strictly observe the instructions given by Officials and Marshals and must follow the route envisaged in the Road book in some parts of the competition route. Failure to comply with this provision will result in sanctions against the relevant competitor, and may even lead to expulsion from the race, at the Stewards' discretion.

9.7 CHECKING OF PERSONAL IDENTIFICATION DEVICE (CPI)

For the entire duration of the event, the Officials on duty can ask the drivers to see their CPI. Drivers that cannot show their stickers could be expelled from the competition by the Stewards.

Article 10 - RUNNING OF THE COMPETITION

10.1 START

The cars will leave one at a time, from a stationary position with the engine running, three cars departing every minute. Each car, once they have been given the "go", will have to free the Departure area as quickly as possible.

Under the control of Officials, departure may take place by pushing the car, if it fails to leave on its own.

Competitors must not stop the competition car in the control areas (between the areas signalling the Start and End areas), exception being made for the check areas where the authorisation stamp will be printed by the Officials, reversing, changing direction, opening doors and in any way hindering the other teams will lead to the application of the penalty as stated in Article 12 of these SR.

The teams that do not make the CO/TC 1 Desenzano del Garda - Departure Leg 1, will be penalized as specified in Article 12 of these SR for each missed transit check. Transit at CO/TC of the Leg 2 - Departure will still be mandatory, under penalty of exclusion.

Drivers must keep to the Official Times stated in the Itinerary Table. No restrictions will be imposed on them as regards the use of time recording equipment. The same may be synchronized with the clock placed at the start of each Leg, without direct connection to the said clock.

Any defect in detection of times, caused by any failure or malfunction of the equipment, will result, for the said checks, in the application of the average to each competitor and/or the annulment of the checks themselves for all competitors.

The organisers will state in the Road book, this will also be indicated on site, a straight stretch of road with measurements, used as the measured base in the preparation of the Road book, and competitors can verify this before the race.

10.2 TIME CONTROLS (CO/TC)

The purpose of the Time Control (CO/TC) is to outline the areas in which the route of the competition is divided, in order to regulate the conduct of the same and to make sure the average speed is respected.

Each competitor (even when 3 cars a minute have been planned for) must be measured on the minute (e.g. for transit time 14:01 it will be possible to transit without penalty from 14:01:00 to 14:01:59).

The excesses as regards the ideal times established will determine the classification.

Penalties for delays and early arrivals at a CO/TC are those stated in Article 12.1 of these SR.

Delays and early arrivals at a CO/TC must not be caught up in the next CO/TC. Teams must leave the "check area" free for transit. They are authorised to enter this area on board their car, in the minute preceding the ideal one for transit, and remain in the area for the time strictly necessary to record the transit time.

When the time is being read, the car must be inside the time reading area. During reading operations, at least one member of the team must be on board the competition car.

The time used for the reading operation is not neutralised in any way. The reading is taken at the moment in which one member of the team hands over the Time Card to the Time-keeper.

If the competition cars that are late or in advance of their ideal times transit through the CO/TC in the minute pertaining to cars on time, the Time-keeper will make a note, on the Time Card of the team that is late or in advance, of the real transit time, which corresponds to the start of the next sector, giving precedence, in the marking operations, to the team with the less delay on the ideal transit time.

All the CO/TCs will be appropriately marked with signs in compliance with the examples attached to these SR (Appendix 6).

Vehicles transiting through an OC/TC in the opposite direction or a direction other than the one decided by the organiser will be excluded from the race.

10.3 TIME TRIALS (PC/TT)

Time Trials (PC/TT) are those timed areas of the route, between two consecutive readings where the drivers must keep to a set time indicated in the Itinerary Table and in the Time Card.

Readings will be done at 1/100th of a second without any tolerance. Differences in the ideal time will, as for the differences read at CO/TC, be used in determining the classification.

PC/TT will be undertaken with departure read at free entrance; the driver will be able to choose freely the start of the PC, nonetheless within approx. 5 seconds from the "all clear" given by the Marshals and/or the Timekeeper in charge.

Various consecutive PC/TTs will be envisaged (interconnected), where the time for passing to the final reading of the previous PC/TT will be the start time of the next PC/TT, and so forth.

For PC/TT located in equipped areas or temporary circuits, competition tracks, kart-racing tracks, and for PC/TTs with lengths less than 300m, an appropriate map will be attached with the Road Book.

All PC/TTs will be properly marked both at the start and at the end, with signs in compliance with the examples attached to these SR (Appendix 6).

In the area of the route between the yellow sign and the beige sign showing the start and end of the measuring area, cars are not allowed to park, stop or open the doors. Should any cars stop in this measuring area due to a breakdown, they must be immediately removed according to the instructions given by the competition official, on penalty of exclusion. Furthermore, unauthorised access by drivers and navigators is also forbidden.

Vehicles transiting through a PC/TC area in the opposite direction than the one decided by the organiser will be excluded from the race.

In the case of absence of a reading by a competitor, or even the absence of a result by one or more PC/TT, irrespective of the reason for this, the competitor will always be assigned a time relating to the missing PC/TT as resulting from the average PC/TT actually clocked by the said competitor in the Laps where the PC/TT are missing. The request will be made at the end of the Lap under consideration.

10.4 AVERAGE TRIALS (PM/AT)

Average Trials (PM/AT) are those sections of the route in a sector in which drivers must maintain a pre-established hourly average, indicated in the TDT and the Time Card.

For the purposes of the Trial classification, all the scores made by proceeding to the arithmetic sum of the scores taken from the "TABLE OF POINTS FOR THE AVERAGE TRIALS" attached to the Supplementary Regulations of the race will be considered; the total of the points will then be divided by the number of scores made in the Trial considered.

The Road book will indicate the starting place and the place that constitutes the theoretical maximum limit of the PM/AT end. In the sector between the beginning and the end of the PM/AT, the average is measured at one or more points not known by the driver: the TDT will indicate the number of measurements made for each PM/AT. For each average trial it will be possible to foresee up to 5 measurements.

The transit time will be recorded per second, rounded down, through the GPS-Tracking equipment installed at the pre-race checks.

10.4.1 START OF AVERAGE TRIALS

- a. the start time of the PM/AT is free and coincides with the passage on the pressure gauge on the start line;
- b. the transit time on the pressure gauge will be lapped manually by the Time-keepers assigned for the purpose, will be measured to the second lapsed.

10.5 PASSAGE CONTROLS (CT/PC)

The purpose of the Passage Controls (CT/PC) is to check the strict adherence to the established route.

The opening and closing times of the CT/PC will be notified by the Clerk of the course Bulletin. At the CT/PCs, drivers must stop the cars in order for the check stamp or "all clear" stamp to be printed in the relative area of the Time Card. The absence of this stamp will mean exclusion.

All the CT/PC areas will be properly marked with signs in compliance with the examples attached to these SR (Appendix 6).

Vehicles transiting through a CT/PC area in the opposite direction or one other than the one decided by the Organiser will be excluded from the race.

10.6 ARRIVAL

Arrival check will be in Brescia – Piazzale Iveco and will be open from 14:30 on Saturday 19 June 2021.

After the arrival CO/TC, competitors will proceed following the instructions given by Marshals, to the arrival ramp.

Article 11 - MAXIMUM LATENESS

A crew will be over the maximum lateness:

- if it transits through a Time Control (CO/TC) with more than 30 minutes delay.
- if it accumulates delays through various Time Controls totalling more than 60 minutes delay.

Only at the starting CO/TC of each Leg will a crew be considered over the maximum time limit if they transit with more than 15 minutes of delay.

The opening and closing times of the Time Trials (PC/TT), the Average Trials (PM / AT) and of the Print Checks (CT /CP) will be notified through a Clerk of the course Bulletin.

Article 12 - PENALTIES AND DISCIPLINARY MEASURES

12.1 TIME CHECKS (CO/TC)

- for every minute or fraction thereof early: 100 negative penalty points
- for the first 2 minutes or fraction thereof late: 25 negative penalty points
- For more than 2 minutes and up to 5 minutes: 50 negative penalty points
- For delay of more than 5 minutes and up to 10 minutes: 100 negative penalty points
- Over 10 minutes and up to 20 minutes: 200 negative penalty points
- For over 20 and up to 30 minutes: 300 negative penalty points
- For each delay beyond the maximum time: 12,000 negative penalty points

12.2 TIME TRIALS (PC/TT)

- for each 1/100 of second early or late: 1 negative penalty point

12.3 SECRET TRANSIT CHECKS

- up to 20 minutes early: 320 negative penalty points
- more than 20 minutes early: 12,000 negative penalty points
- 2nd time more than 20 minutes early: exclusion

12.4 TIME CARD

- alterations, changes or corrections not endorsed by Officials: exclusion
- Failure to record a CO/TC: 12,000 negative penalty points
- Lack of a control stamp (CT/PC): 12,000 negative penalty points
- Failure to return to the CO/TC of Leg arrival: exclusion

12.5 OTHER PENALTIES

- refusal to start at the hour and in the set order: 100 negative penalty points
- stopping the car in the control area (stationary wheel): 100 negative penalty points
- unauthorised access of the crew in the check area (subject to further action): 300 negative penalty points
- missing transit or time annotation at any control point: 12,000 negative penalty points
- unauthorized stopping in a control area: 12,000 negative penalty points
- blocking the passage and/or damaging other crews: exclusion
- for non-sportsmanlike behaviour: from warning to exclusion
- for passage in a control area in a wrong or different direction: exclusion
- for infringements of the Road Safety Rules: up to exclusion
- document irregularities during administrative checks: non-acceptance
- failure to comply with the checking times: up to non-acceptance
- not starting at the first and the second Legs: exclusion
- allowing a person other than a crew member to drive the car: exclusion
- lack of a competition number or competition license plate: fine
- lack of two or all of the competition numbers: exclusion

- failure to comply with provisions concerning the synchronization of chronometers: up to exclusion
- for non-prudent behaviour of a crew member, or assistants or team car: up to exclusion
- for leaning out of a moving car: up to exclusion
- Failure to comply with the orders of Officials and Marshals: up to exclusion
- Article 8.6 - first offense: 1.000 negative penalty points
- Article 8.6 - second offense: 12,000 negative penalty points
- infringements of the rules on advertising on cars in the race: 12,000 negative penalty points

Article 13 - CLASSIFICATION-PROTESTS AND APPEALS

13.1 CLASSIFICATION

The following standings will be drafted:

- a) "Overall Ferrari Tribute 1000 Miglia 2022" an overall classification including all the cars admitted to the competition called
- b) "Modern" Vehicles – from 1991 to today (art. 6.3.2)
- c) "Historic" Vehicles – until 1990 (art. 6.3.3)

13.2 COMPILATION AND PUBLICATION OF RESULTS

Classifications will be drafted on the basis of points scored by each crew in the PC/TT, in the PM/AT, the CO/TC and calculated according to the "points table" (Appendixes 8 and 9) and of all the penalties applied by the Clerk of the Course or by the Stewards.

"Differences" are not provided for.

The crew that receives the highest number of points will be declared the winner.

In case of a tie in the final classification, the winning position will be awarded to the crew/crews that has/have accumulated the least number of penalties, not points, during the race.

Those crews that do not transit or do not hand in the Time Card to the final arrival point, (the arrival of Leg 4), will not be classified. The results will be published as per the Programme.

13.3 PROTESTS AND APPEALS

Protests and appeals must be submitted in the manner and within the terms established by the National Sporting Regulations.

- For each protest, the security deposit is € 350,00.
- For each appeal, the security deposit is € 3.000,00.

13.4 TERMS FOR SUBMISSION OF PROTESTS OR REQUESTS OF TIME CHECK

The classifications compiled at the end of Legs 1, 2 and 3 are to be considered final in the elements used to complete them. These classifications will be published 30 minutes before the start of each Leg: competitors may submit a complaint (including a request of timing verification) against published documents, until the time of their individual starts by presenting a document with reasons for the dispute to the Competitor Relations Officers present at the start.

Article 14 - PRIZES

The event will have the following honour prizes:

- Classification "Overall Tribute 1000 Miglia 2022" among all eligible vehicles (Art. 13.1.a) For the first 3 classified;
- "Modern" vehicles – from 1991 to today (art. 13.1.b) For first place of the group classification;
- "Historic" vehicles – until 1990 (art. 13.1.c) For first place of the group classification.
- Other Prize:
The Prize "7° Stefano Rabbito Trophy" will be awarded in the Roma Ramp to the first crew classified in the "Overall Ferrari Tribute 1000 Miglia 2022" classification considered at the CO/TC 8 Roma /Villa Borghese (excluded eventual penalties at that CO/TC)

The prizes are not cumulative, so the winners more than one ranking will only be awarded the prize of the most important ranking.

Crews that are not present at the prize-giving will forfeit their prizes without the classification being changed. Honour prizes will be awarded to all classified crews.

Article 15 - GENERAL RULES

15.1 RESPONSIBILITIES

By the very act of entering for this event, each competitor declares for themselves and their drivers, for the staff on their own service vehicles and accompanying vehicles, for their dependents and assignees:

- to recognize and accept the provisions of the National Sporting Regulations (and Sector Rules) and the present SR, committing themselves to respect and to enforce them;
- under their direct responsibility, to have their Drivers, their assistance personnel, employees and appointees sign these SRR for acceptance, which shall be strictly observed;
- to relieve the Italian Automobile Club, the ACI Sport, the ACI Brescia, the Organiser 1000 Miglia S.r.l. and all persons involved in the organisation, as well as the Automobile Clubs involved in the event, the Local Authorities involved, the Officials and the owners of the routes where the competition takes place from any liability regarding any damages to competitors, or their drivers, navigators, employees and agents, or things, or produced or caused to third parties or of objects by the competitor himself, his drivers, navigators, employees and agents.

15.2 DISPUTES

Competitors undertake to resolve any dispute of a patrimonial nature that may arise due to facts arising from the application and/or interpretation of these SRR and from the course of the Event by means of the sports arbitration provided for in articles 236 et seq. of the National Sporting Regulations and the ACI Sporting Justice Regulations for disputes of a sporting nature that occurred during the Event. All disputes of a technical and disciplinary nature definitively decided by the Organiser and/or its own bodies that have given rise to penalisation or exclusion from the Event rankings or to financial penalties are expressly excluded from the sporting arbitration;

15.3 ADVERTISING

No form of advertisement may be placed on the car, unless this is expressly provided for by the organiser, which will be announced by a special information bulletin, in compliance with the provisions of current ACI Sport legislation.

The names of the crewmembers can be written on each of the sides of the competition cars in the maximum dimension of 10 x 40 cm per side.

A Club logo, not having advertising purpose (all or part thereof), can appear on each side of competition cars occupying a maximum space of 10 x 10 cm, per side or equivalent surface.

The original livery is tolerated as regards identification badges, even if they constitute advertising, limited however to what was originally used for that specific vehicle identified with the chassis number.

Any form of advertising that does not correspond to what is stated in this article will be removed by the Organiser and/or by Officials who will carry out checks before and during the race.

The breach of the provisions of this article will be sanctioned with 12,000 negative penalty points. Those crews that will be found non-compliant with the provisions set forth above will be denied participation in future editions of the event. The organiser reserves the right to charge the offending crew with damages resulting from the contravention of this Article.

The participants therefore agree to assume the obligation to pay compensation for all damages suffered by the organiser and third parties in general, relieving the same from any liability, for any and all liability and/or damages resulting from the violation of the abovementioned prohibition.

15.4 COMPETITION NUMBER PLATES

All the competition numbers (plates) handed over by the Organiser to the competitor must be attached to the competition cars. The discovery of one of the delivered competition number plates on a car other than

the competition car, will lead to a penalty that could result in the immediate exclusion of the same competition car from the competition.

15.5 OTHER PLATES PROVIDED BY THE ORGANIZER

All cars with race number plates of the FERRARI TRIBUTE 1000 MIGLIA 2022 event applied, bearing the wording of function

- ORGANIZATION
- MEDIA
- GUEST CAR

being part of the race convoy and also authorized to transit on roads temporarily closed to ordinary traffic are cars and crews not in the race and always travel under the responsibility of their owners and drivers.

Article 16 - INSURANCE

The Organizer adheres to the current sporting insurance policy: the race is covered by the CL Insurance Policy provided for in Article 56 of the RNS ACI Sport.

In this context, he confirms that he is fully aware that the CL policy, as mentioned in Article 56 of the RSN, complies with the regulations provided for in Article 124 of the insurance code, with minimum legal requirements, integrated by the organiser of 1000 Miglia S.r.l. up to the following limit of liability by type of risk:

- a) RCT (CLR) insured limits of liability –Civil Liability Risks (Third Parties)
 - € 25.000.000,00 per accident, with the limit of:
 - € 25.000.000,00 for personal damages, regardless of the number of people involved, and of
 - € 25.000.000,00 for damages to objects and animals
- b) RCO insured limits of liability – Organiser Risks
 - € 25.000.000,00 per accident
 - € 25.000.000,00 per person

This policy does not relieve the Competitors and drivers from any liability they could incur beyond the object of the insurance and additional general and special policy conditions as published on the federal site and nonetheless requested from the Insurance Company.

The liability insurance of the Organisers will be operational, for each competitor, from the moment of completion of its administrative checks and will cease upon arrival or at the time of closing of the Time Control subsequent to that in which the competitor has withdrawn.

Article 17 - APPENDIXES

The following appendixes are an integral part of these SR:

- **APPENDIX 1:** Facsimile of the Medical Certificate for non-competitive sports activities;
- **APPENDIX 2:** Facsimile of the Medical Certificate for competitive sports activities;
- **APPENDIX 3:** Positioning of competition numbers on the cars;
- **APPENDIX 4:** Itinerary Table: (the definitive Itinerary Table will be communicated with the Road book);
- **APPENDIX 5:** Maps of the route: (will be communicated with the Road book);
- **APPENDIX 6:** Signage Posters of Checks;
- **APPENDIX 7:** Points table for the Time Trial (TT);
- **APPENDIX 8:** Points table for the Average Tests (AT).

Ferrari Tribute 1000 Miglia 2022 | Special Race Regulations

Supplementary Regulations for the Grande Evento for historic cars to be held on 13/18 June 2022 called FERRARI TRIBUTE 1000 MIGLIA 2022

The LEGAL REPRESENTATIVE states that modifications to the Special Regulations of the type drawn up by ACT have been done; each modification has been highlighted in bold.

The Clerk of the course
(has read and accepts the appointment)

Lucio DE MORI

_____signed_____

The legal representative of the Organising Body

Alberto PIANTONI

_____signed_____

For the Regional Delegation

Alessandro TIBILETTI

_____signed_____

SEEN AND APPROVED
THE SECRETARY OF ACI SPORTS BODIES
Marco FERRARI

These SR have been approved on _____ with approval number _____.

Allegato 1: Fac-simile Certificato Medico Attività Sportiva non agonistica
Attachment 1: Facsimile Medical Certificate for non-competitive Sporting Activities

Certificato di idoneità alla pratica di attività sportiva di tipo non agonistico
Certificat d'aptitude à la pratique d'un sport non professionnel
Medical certificate for non-competitive sport activity

Sig. - Sig.ra \ Mons. - Mme \ Mr. - Mrs : _____

nato - nata a \ né à \ born in: _____

il \ le \ on: _____

indirizzo \ adresse \ address : _____

Il soggetto, sulla base della visita medica da me effettuata, dei valori pressione arteriosa rilevati, nonché dal referto del tracciato ECG eseguito in data _____ non presenta controindicazioni in atto alla pratica di attività sportiva non agonistica. (legge 125,art.4, comma 10s and DMS del 8.8.2014)

Based on a physical examination, including blood pressure readings, and from the results of the ECG test, carried out on _____ I hereby declare my client is in good health and fit to practice non-competitive sport activities (Italian law 125, art.4 comma 10s and DMS from 8.8.2014)

Sur la base d'un examen médical réalisé par mes soins, des valeurs de la pression artérielle relevées ainsi que du résultat du test ECG effectué le _____ le patient ne présente pas de contre-indication à la pratique d'activités sportives non professionnels (loi Italienne 125,art4, comma 10s et le DMS du 8.8.14).

Il presente certificato ha validità annuale dalla data del rilascio
Ce certificat est valable 1 an
This certificate is valid for a period of one year

Luogo | Lieu | Issued in: _____ *il | le | on:* _____

Il Medico \ le Medecin \ the Doctor (*firma e timbro - signature et tampon - signature and stamp*):

Allegato 2: Fac-simile Certificato Medico Attività Sportiva agonistica

Regione U.S.L.....

Certificato di idoneità
all'attività Sportiva Agonistica
(Art. 5 - D.M. 18.2.82)

Certificato N°

Cognome

Nome

Nato a

il

Residenza e/o domicilio

Documento d'identità

Sport per cui è richiesta la visita

L'atleta di cui sopra sulla base della visita medica e dei relativi accertamenti non presenta controindicazioni

in atto alla pratica dello sport

Il presente certificato ha validità di

e scadrà il

Data

IL MEDICO

.....
TIMBRO CON CODICE IDENTIFICATIVO E FIRMA

Attachment 2: Facsimile Medical Certificate for competitive Sporting Activities

Region USL

Certificate of Fitness
for Competitive Sporting activities
(Art. 5 - D.M. 82.2.82)

Certificate N°

Surname

Name

Born in

On

Resident and/or Domicile in

Identity Document

Sport for which the examination is requested

The abovementioned athlete, based on the medical examinations carried out and the relative results, does not present any current contraindications for the following sport

..... This certificate is

valid for And will expire on

.....

Date

THE DOCTOR

.....
STAMP WITH IDENTIFICATION CODE AND SIGNATURE

Allegato 3: Posizionamento Numeri di Gara sulle vetture
Attachment 3: Positioning of Race Numbers on the cars

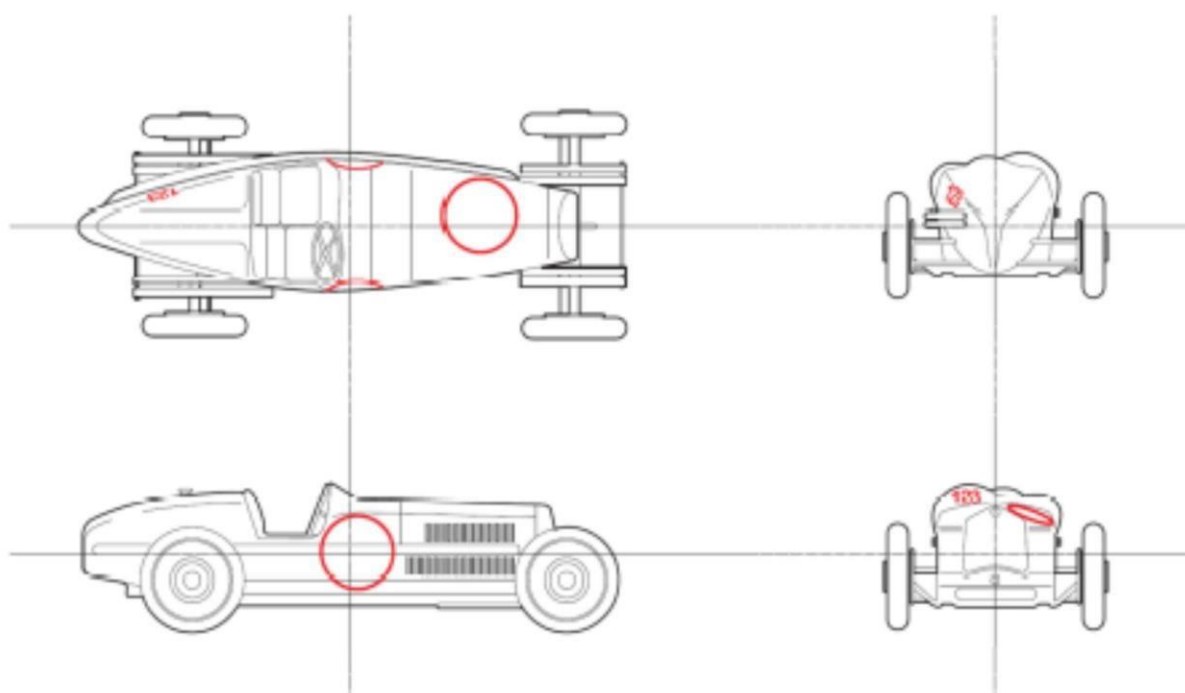
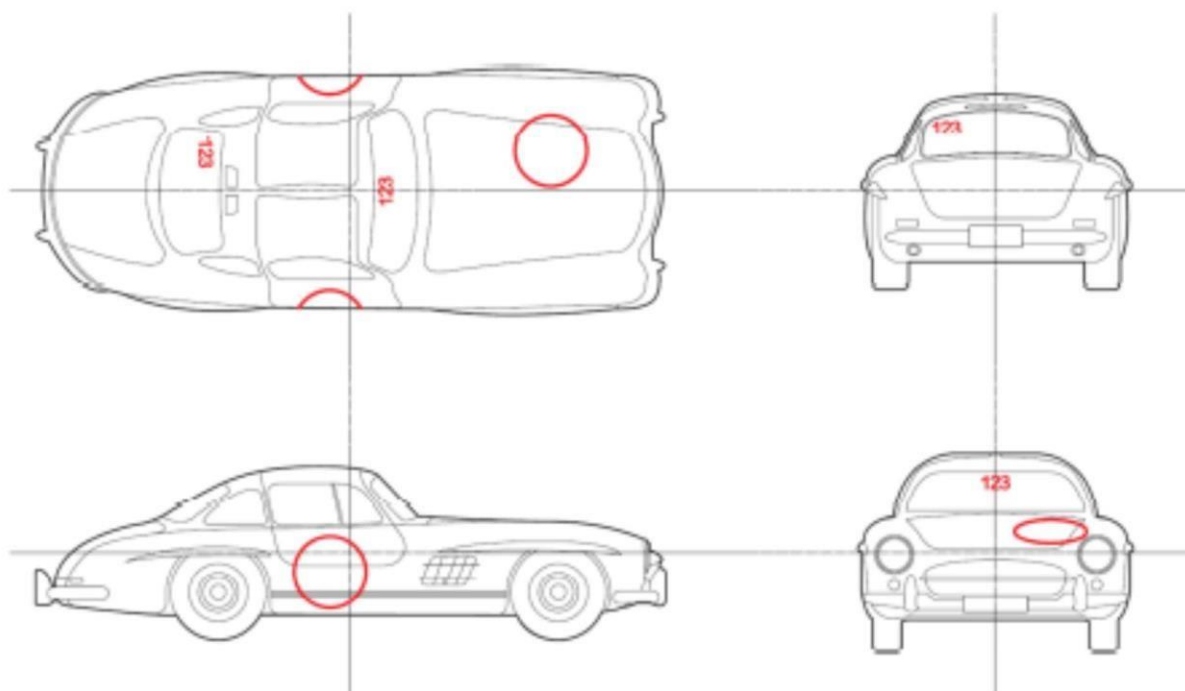













Allegato 4: Tabella delle Distanze e dei Tempi
Attachment 4: Itinerary table (the TDT will be distributed together with the Road book)

Allegato 5: Mappa del Percorso di Gara
Attachment 5: Maps of the route



Allegato 6: Cartellonistica dei controlli
Attachment 6: Control Signs

CARTELLI DEI CONTROLLI - CONTROL SIGNS

CO / TC*	INIZIO ZONA CONTROLLO • CONTROL AREA START  GIALLO/YELLOW mt 25 circa - approx.	CONTROLLO • CONTROL  ROSSO/RED mt 25 circa - approx.	FINE ZONA CONTROLLO • CONTROL AREA END  BEIGE mt 25 circa - approx.
	CT / PC**		
PC*** SINGOLE O CONCATENATE LUNGHEZZA INFERIORE / UGUALE A 300 MT.	INIZIO ZONA CONTROLLO • CONTROL AREA START  GIALLO/YELLOW mt 25 circa - approx.	CONTROLLO • CONTROL  ROSSO/RED lunghezza inferiore/uguale - length inferior/equal to 300mt.	INIZIO ZONA CONTROLLO • CONTROL AREA START  BEIGE lunghezza inferiore/uguale - length inferior/equal to 300mt.
	TT**** SINGLE OR CONNECTED LENGTH INFERIOR / EQUAL TO 300 MT.		
PC*** SINGOLE O CONCATENATE LUNGHEZZA SUPERIORE A 300 MT.	INIZIO ZONA CONTROLLO • CONTROL AREA START  GIALLO/YELLOW mt 25 circa - approx.	CONTROLLO • CONTROL  ROSSO/RED mt 25 ca - approx.	INIZIO ZONA CONTROLLO • CONTROL AREA START  BEIGE mt 25 circa - approx.
	TT**** SINGLE OR CONNECTED LENGTH SUPERIOR TO 300 MT.		
PM PROVA DI MEDIA CON UNO O PIU' CONTROLLI SEGRETI AT AVERAGE TEST WITH ONE OR MORE SECRET CONTROLS	INIZIO ZONA CONTROLLO • CONTROL AREA START  GIALLO/YELLOW mt 25 circa - approx.	CONTROLLO • CONTROL  ROSSO/RED	INIZIO ZONA CONTROLLO • CONTROL AREA START  BEIGE
	LIMITE DELL'ESTENSIONE DELLA PM - LIMIT AT EXTENTION		
estensione della prova di media / extention of average test			

***Ai Controlli Orari NON SEGUITI da Start Prova Cronometrata**

Le vetture sono autorizzate ad entrare nella zona di controllo (tra il cartello giallo e quello rosso di controllo) nel minuto che precede il loro minuto teorico di transit (solo se la zona è già stata liberata dalle vetture che precedono) oppure nel loro minuto teorico di transit e devono consegnare la tabella di marcia al cronometrista, per l'annotazione dell'orario di transit. I membri dell'equipaggio sono autorizzati a rimanere a bordo della vettura.

****Ai Controlli Timbro**

I membri dell'equipaggio devono rimanere a bordo della vettura e consegnare al commissario la tabella di marcia, per l'apposizione del timbro, senza iscrizione dell'orario di transit; la sosta nella zona deve essere limitata all'operazione di timbratura.

*****Nelle Prove Cronometrate**

Tra il cartello giallo di inizio ed il cartello beige di fine zona controllo è vietato l'arresto (fermo vettura/fermo ruote) e la sosta della vettura.

***At the Time Controls NOT FOLLOWED by Start Time Trials**

The cars are authorized to enter the control area (between the yellow and red control sign) in the minute preceding their theoretical transit minute (only if the area has already been freed from the cars ahead) or during their theoretical transit minute and must hand in the time card to the timekeeper, in order for him to note down the transit time. Crew members are allowed to remain on board the car.

****During the Time Trials**

Between the yellow sign at the beginning and the beige sign at the end of the control area, it is forbidden to stop (vehicle stopped/wheels stopped) and park the car.

*****At the Stamp Controls**

The crew members must remain on board the car and hand in the time card to the Marshal, where he will put the stamp, without inscription of the transit time; parking in the area must be limited only to the stamping operation.

Allegato 7: Tabella dei punteggi per le PC - Points table for the TT (PC/TT)

FERRARI TRIBUTE 1000 MIGLIA 2022
TABELLA DEI PUNTEGGI PER LE PROVE CRONOMETRATE

centesimi di secondo		centesimi di secondo		centesimi di secondo		centesimi di secondo	
penalità	punti	penalità	punti	penalità	punti	penalità	punti
0	420	42	158	84	116	126	74
1	395	43	157	85	115	127	73
2	370	44	156	86	114	128	72
3	350	45	155	87	113	129	71
4	330	46	154	88	112	130	70
5	310	47	153	89	111	131	69
6	291	48	152	90	110	132	68
7	272	49	151	91	109	133	67
8	254	50	150	92	108	134	66
9	236	51	149	93	107	135	65
10	226	52	148	94	106	136	64
11	217	53	147	95	105	137	63
12	212	54	146	96	104	138	62
13	207	55	145	97	103	139	61
14	203	56	144	98	102	140	60
15	200	57	143	99	101	141	59
16	198	58	142	100	100	142	58
17	196	59	141	101	99	143	57
18	194	60	140	102	98	144	56
19	192	61	139	103	97	145	55
20	190	62	138	104	96	146	54
21	188	63	137	105	95	147	53
22	186	64	136	106	94	148	52
23	184	65	135	107	93	149	51
24	182	66	134	108	92	150	50
25	180	67	133	109	91	151	49
26	178	68	132	110	90	152	48
27	176	69	131	111	89	153	47
28	174	70	130	112	88	154	46
29	172	71	129	113	87	155	45
30	170	72	128	114	86	156	44
31	169	73	127	115	85	157	43
32	168	74	126	116	84	158	42
33	167	75	125	117	83	159	41
34	166	76	124	118	82	160	40
35	165	77	123	119	81	161	39
36	164	78	122	120	80	162	38
37	163	79	121	121	79	163	37
38	162	80	120	122	78	164	36
39	161	81	119	123	77	165	35
40	160	82	118	124	76	166	34
41	159	83	117	125	75	167	33

TABELLA DEI PUNTEGGI PER LE PROVE CRONOMETRATE

centesimi di secondo		centesimi di secondo		centesimi di secondo		centesimi di secondo	
penalità	punti	penalità	punti	penalità	punti	penalità	punti
168	32	205	0	242	0	279	0
169	31	206	0	243	0	280	0
170	30	207	0	244	0	281	0
171	29	208	0	245	0	282	0
172	28	209	0	246	0	283	0
173	27	210	0	247	0	284	0
174	26	211	0	248	0	285	0
175	25	212	0	249	0	286	0
176	24	213	0	250	0	287	0
177	23	214	0	251	0	288	0
178	22	215	0	252	0	289	0
179	21	216	0	253	0	290	0
180	20	217	0	254	0	291	0
181	19	218	0	255	0	292	0
182	18	219	0	256	0	293	0
183	17	220	0	257	0	294	0
184	16	221	0	258	0	295	0
185	15	222	0	259	0	296	0
186	14	223	0	260	0	297	0
187	13	224	0	261	0	298	0
188	12	225	0	262	0	299	0
189	11	226	0	263	0	300	0
190	10	227	0	264	0		
191	9	228	0	265	0		
192	8	229	0	266	0		
193	7	230	0	267	0		
194	6	231	0	268	0		
195	5	232	0	269	0		
196	4	233	0	270	0		
197	3	234	0	271	0		
198	2	235	0	272	0		
199	1	236	0	273	0		
200	0	237	0	274	0		
201	0	238	0	275	0		
202	0	239	0	276	0		
203	0	240	0	277	0		
204	0	241	0	278	0		

NOTA: il coefficiente assegnato alla vettura deve essere moltiplicato per i punti

Allegato 8: Tabella dei punteggi per le PM - Points table for the AT (PM/AT)**FERRARI TRIBUTE 1000 MIGLIA 2022
TABELLA DEI PUNTEGGI PER LE PROVE DI MEDIA**

al secondo			al secondo			al secondo			al secondo		
penalità	punti ANTICIPO	punti RITARDO	penalità	punti ANTICIPO	punti RITARDO	penalità	punti ANTICIPO	punti RITARDO	penalità	punti ANTICIPO	punti RITARDO
0	420	420	42	53	158	84	0	116	126	-108	74
1	395	395	43	52	157	85	0	115	127	-111	73
2	370	370	44	51	156	86	0	114	128	-114	72
3	350	350	45	50	155	87	0	113	129	-117	71
4	330	330	46	48	154	88	0	112	130	-120	70
5	310	310	47	46	153	89	0	111	131	-123	69
6	291	291	48	44	152	90	0	110	132	-126	68
7	272	272	49	42	151	91	-3	109	133	-129	67
8	254	254	50	40	150	92	-6	108	134	-132	66
9	236	236	51	38	149	93	-9	107	135	-135	65
10	226	226	52	36	148	94	-12	106	136	-138	64
11	200	217	53	34	147	95	-15	105	137	-141	63
12	185	212	54	32	146	96	-18	104	138	-144	62
13	170	207	55	30	145	97	-21	103	139	-147	61
14	155	203	56	28	144	98	-24	102	140	-150	60
15	140	200	57	26	143	99	-27	101	141	-153	59
16	135	198	58	24	142	100	-30	100	142	-156	58
17	130	196	59	22	141	101	-33	99	143	-159	57
18	125	194	60	20	140	102	-36	98	144	-162	56
19	120	192	61	18	139	103	-39	97	145	-165	55
20	115	190	62	16	138	104	-42	96	146	-168	54
21	110	188	63	14	137	105	-45	95	147	-171	53
22	105	186	64	12	136	106	-48	94	148	-174	52
23	100	184	65	10	135	107	-51	93	149	-177	51
24	95	182	66	8	134	108	-54	92	150	-180	50
25	90	180	67	6	133	109	-57	91	151	-183	49
26	85	178	68	4	132	110	-60	90	152	-186	48
27	80	176	69	2	131	111	-63	89	153	-189	47
28	75	174	70	0	130	112	-66	88	154	-192	46
29	70	172	71	0	129	113	-69	87	155	-195	45
30	65	170	72	0	128	114	-72	86	156	-198	44
31	64	169	73	0	127	115	-75	85	157	-201	43
32	63	168	74	0	126	116	-78	84	158	-204	42
33	62	167	75	0	125	117	-81	83	159	-207	41
34	61	166	76	0	124	118	-84	82	160	-210	40
35	60	165	77	0	123	119	-87	81	161	-213	39
36	59	164	78	0	122	120	-90	80	162	-216	38
37	58	163	79	0	121	121	-93	79	163	-219	37
38	57	162	80	0	120	122	-96	78	164	-222	36
39	56	161	81	0	119	123	-99	77	165	-225	35
40	55	160	82	0	118	124	-102	76	166	-228	34
41	54	159	83	0	117	125	-105	75	167	-231	33

TABELLA DEI PUNTEGGI PER LE PROVE DI MEDIA

al secondo			al secondo			al secondo			al secondo		
penalità	punti ANTICIPO	punti RITARDO	penalità	punti ANTICIPO	punti RITARDO	penalità	punti ANTICIPO	punti RITARDO	penalità	punti ANTICIPO	punti RITARDO
168	-234	32	205	-345	0	242	-456	0	279	-567	0
169	-237	31	206	-348	0	243	-459	0	280	-570	0
170	-240	30	207	-351	0	244	-462	0	281	-573	0
171	-243	29	208	-354	0	245	-465	0	282	-576	0
172	-246	28	209	-357	0	246	-468	0	283	-579	0
173	-249	27	210	-360	0	247	-471	0	284	-582	0
174	-252	26	211	-363	0	248	-474	0	285	-585	0
175	-255	25	212	-366	0	249	-477	0	286	-588	0
176	-258	24	213	-369	0	250	-480	0	287	-591	0
177	-261	23	214	-372	0	251	-483	0	288	-594	0
178	-264	22	215	-375	0	252	-486	0	289	-597	0
179	-267	21	216	-378	0	253	-489	0	290	-600	0
180	-270	20	217	-381	0	254	-492	0	291	-603	0
181	-273	19	218	-384	0	255	-495	0	292	-606	0
182	-276	18	219	-387	0	256	-498	0	293	-609	0
183	-279	17	220	-390	0	257	-501	0	294	-612	0
184	-282	16	221	-393	0	258	-504	0	295	-615	0
185	-285	15	222	-396	0	259	-507	0	296	-618	0
186	-288	14	223	-399	0	260	-510	0	297	-621	0
187	-291	13	224	-402	0	261	-513	0	298	-624	0
188	-294	12	225	-405	0	262	-516	0	299	-627	0
189	-297	11	226	-408	0	263	-519	0	300	-630	0
190	-300	10	227	-411	0	264	-522	0	>300	-12000	0
191	-303	9	228	-414	0	265	-525	0			
192	-306	8	229	-417	0	266	-528	0			
193	-309	7	230	-420	0	267	-531	0			
194	-312	6	231	-423	0	268	-534	0			
195	-315	5	232	-426	0	269	-537	0			
196	-318	4	233	-429	0	270	-540	0			
197	-321	3	234	-432	0	271	-543	0			
198	-324	2	235	-435	0	272	-546	0			
199	-327	1	236	-438	0	273	-549	0			
200	-330	0	237	-441	0	274	-552	0			
201	-333	0	238	-444	0	275	-555	0			
202	-336	0	239	-447	0	276	-558	0			
203	-339	0	240	-450	0	277	-561	0			
204	-342	0	241	-453	0	278	-564	0			

NOTA: il coefficiente assegnato alla vettura deve essere moltiplicato per i punti